

Como Shelf

Design by BoConcept

Samlevejledning - Assembly Instructions - Montageanleitung - Instructions d'assemblage - Instrucciones de montaje

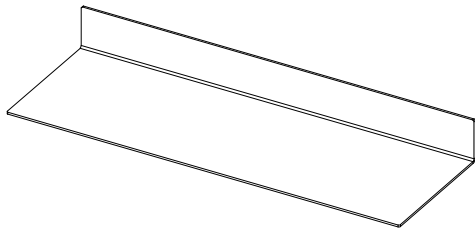

7030

60 x 20,8 x 6,5 cm / Max. 5kg

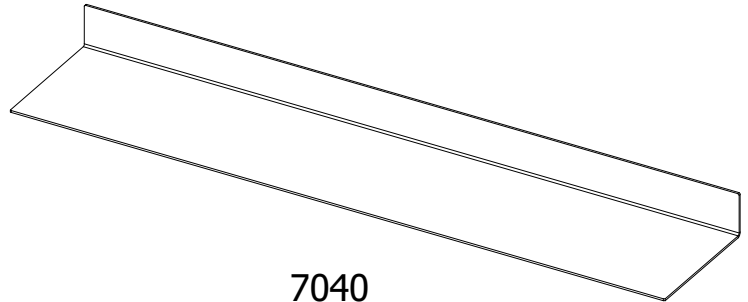

7040

100 x 20,8 x 6,5 cm / Max. 8kg

340-7030

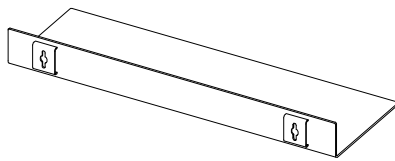

A x 1

600 x 208 x 65 mm
Como 7030

Sparebag: 937000090



B x 2

970001742
30 x 6 x 0,5 mm



C x 2

970001743
30 x 6 x 1 mm

340-7040

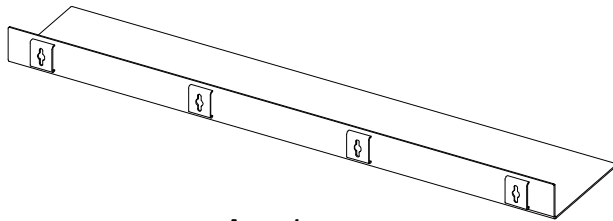

A x 1

1000 x 208 x 65 mm
006311

Sparebag: 937000135



B x 4

970001742
30 x 6 x 0,5 mm



C x 4

970001743
30 x 6 x 1 mm

Værktøj - Werkzeuge - Tools - Outils

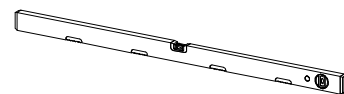
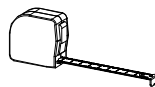

Example 340-7030

A

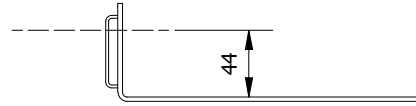
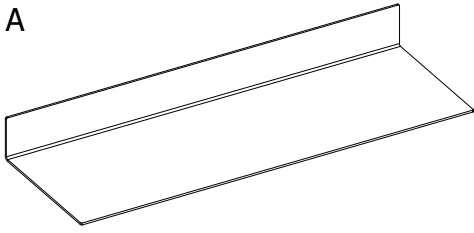

B

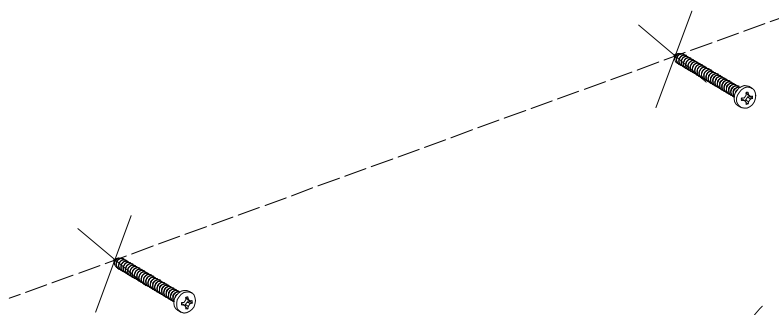
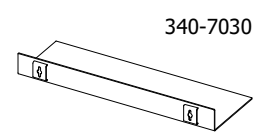
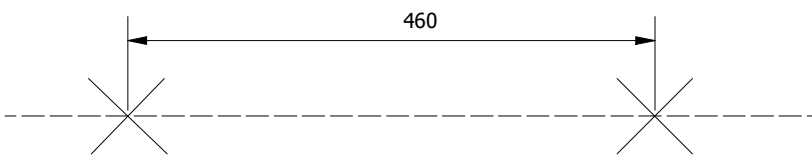
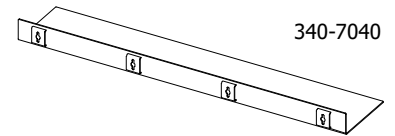
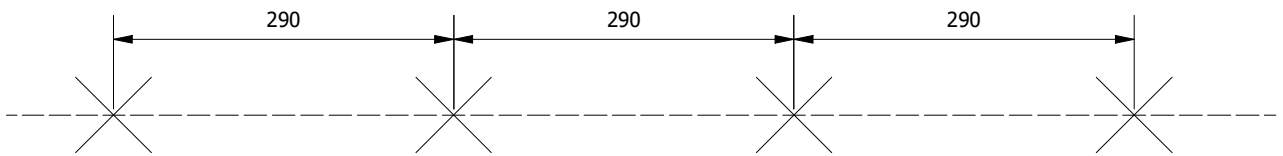
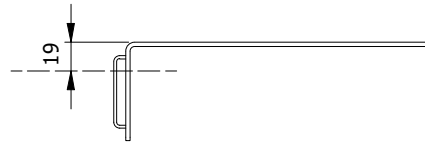
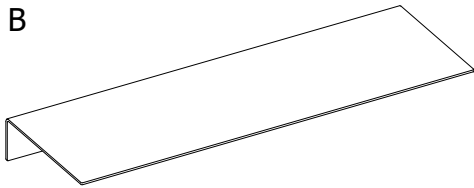

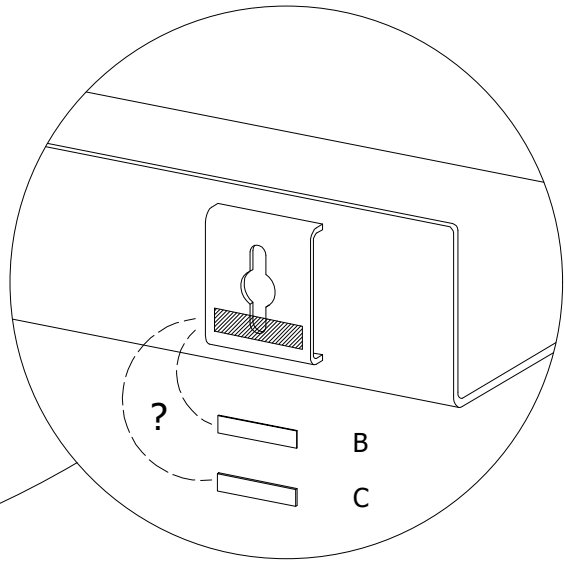
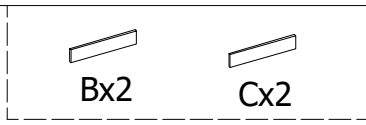
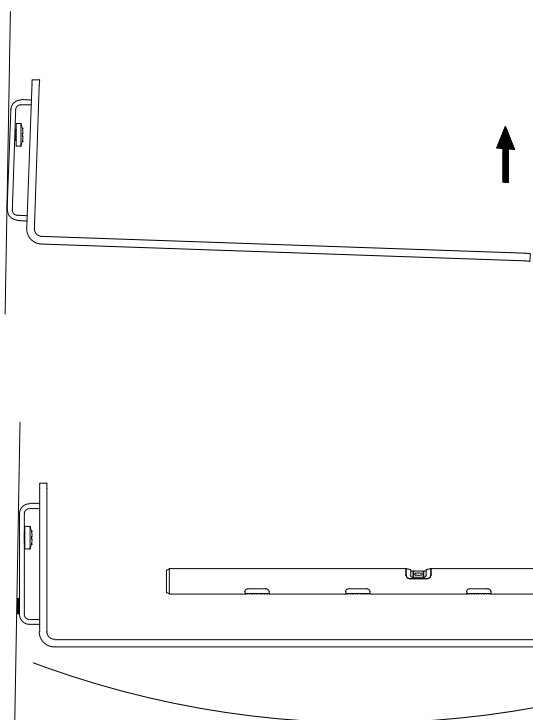
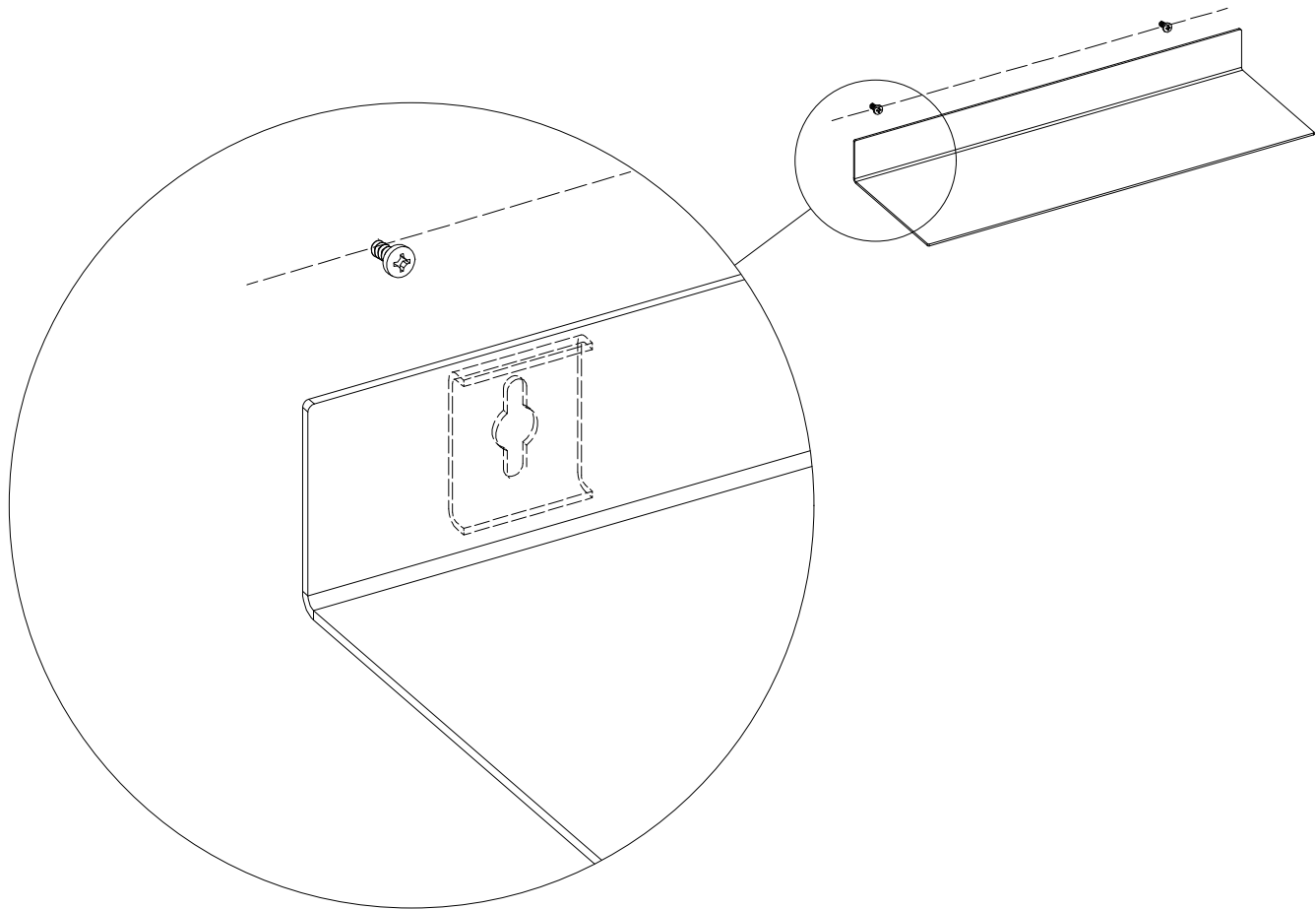





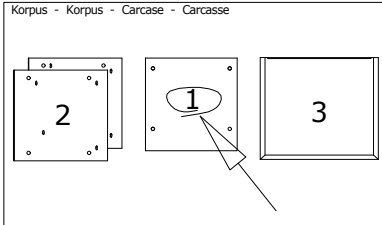

! DK Ved reklamation oplyses følgende:
 D Im Reklamationsfall, bitte folgendes erläutern:
 US In case of claims, please state the following:
 F En cas de reclamation, veuillez indiquer:
 NL Bij service volgene mededelen
 E En caso de reclamacion, indicar lo siguiente:
 P No caso de reclamação, por favor indique o seguinte:
■ JP お気づきの点等ございましたら、以下の点をお知らせください。

Example!



Beslag - Fittings - Beschläge - Set de Montage		
 A X 8 1972000014	 B X 12 1972000004	 C X 4 1979110830
 D X 2 1970120000	 H X 2 1978504022	 J X 8 1978204210