

Adelaide dining chair

Design by BoConcept

Samvejledning - Assembly Instructions - Montageanleitung - Instructions d'assemblage - Instrucciones de montaje

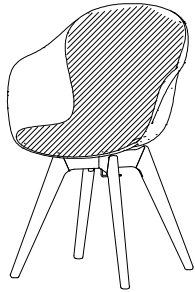

402-D061
1x2200, 1x2180
86,0x60,0x57,5

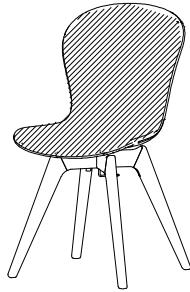

402-D062
1x2200, 1x2130
86,0x45,0x57,5

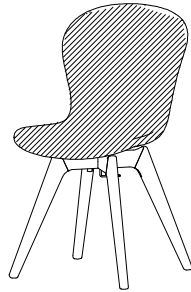

402-D063
1x2200, 1x2170
86,0x45,0x57,5

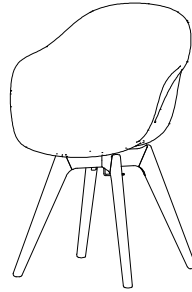

402-D064
1x2200, 1x2100
86,0x45,0x57,5

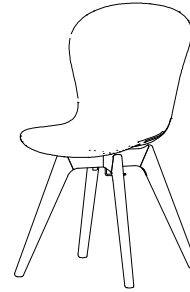

402-D065
1x2200, 1x2110
86,0x45,0x57,5

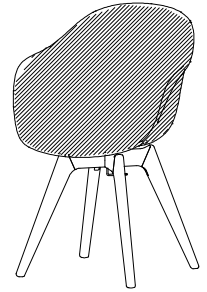

402-D066
1x2200, 1x2240
86,0x45,0x57,5

Colli 2

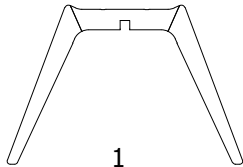

1
004764

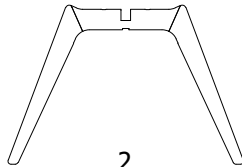

2
004765



3
004145



4
004939

Beslag - Beschläge - Fittings - Set de montage
no. 937000001



A x 4
979900213
Screw ma M6x12 black



B x 4
970001368
Distance Washer Black



C x 1
970001597
Hex screw M6x35 Black



D x 4
970001378
M6x73 mm Black



E x 4
970001598
Screw flh 4x30 black



F x 1
970001692
Allen key 4 mm

FIG.
1

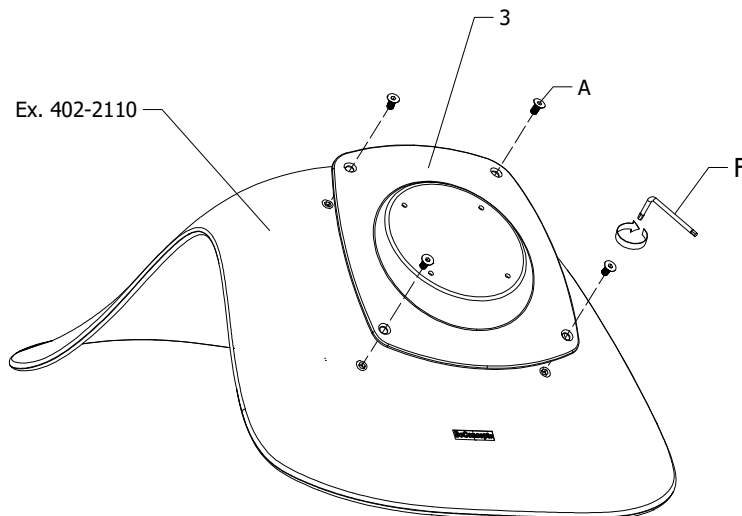

A x 4



F

125kg/275lb



FIG. 2

EX. 402-D065

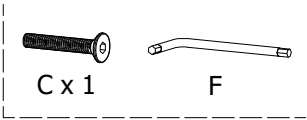

Step 1 = 50%

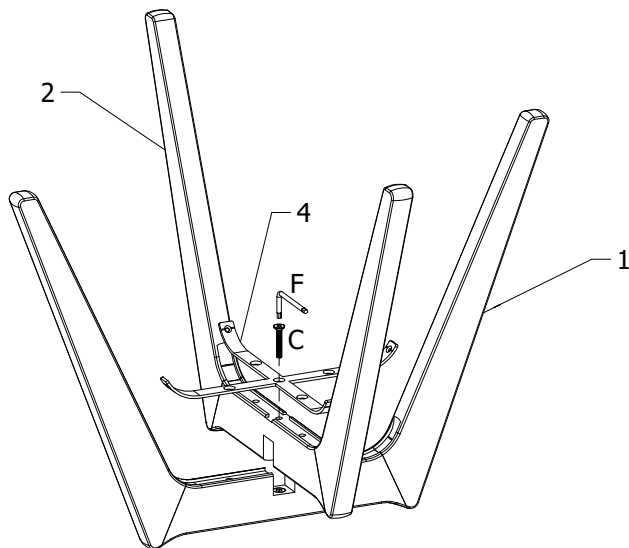
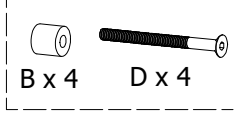
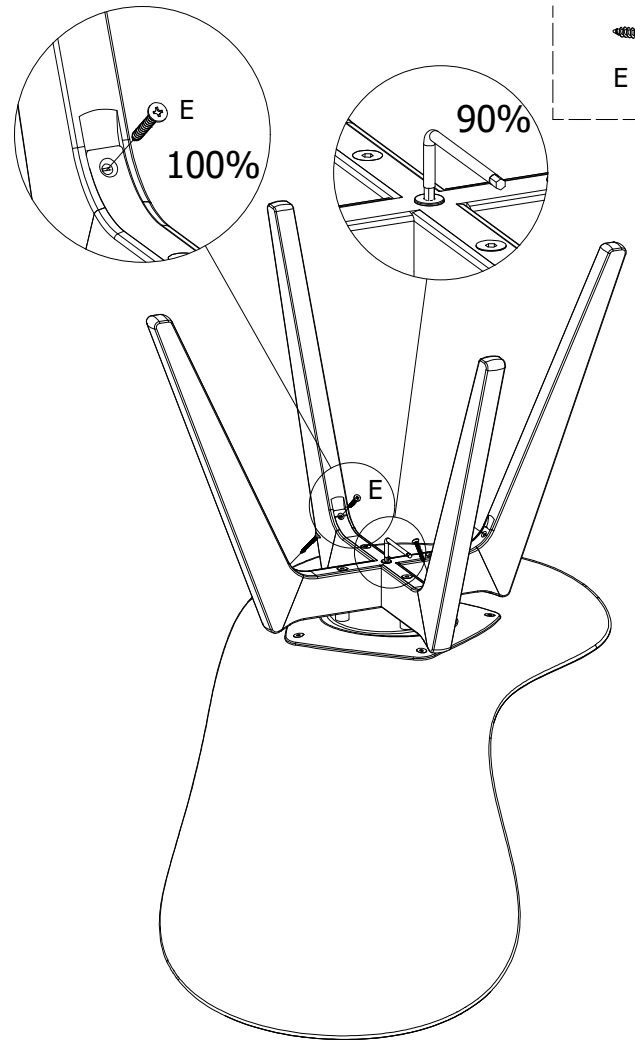
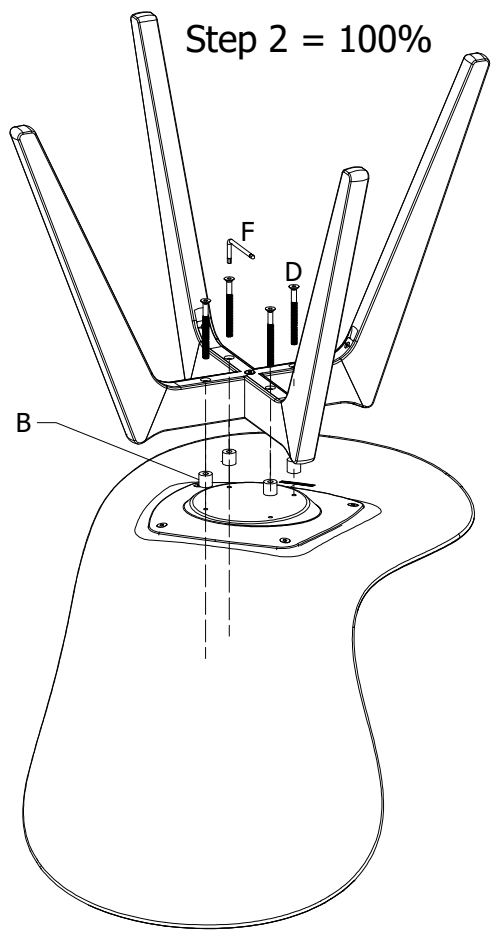

FIG. 3



Step 2 = 100%



! DK Ved reklamation oplyses følgende:
 D Im Reklamationsfall, bitte folgendes erläutern:
 US In case of claims, please state the following:
 F En cas de reclamation, veuillez indiquer:
 NL Bij service volgene mededelen
 E En caso de reclamacion, indicar lo siguiente:
 P No caso de reclamação, por favor indique o seguinte:
■ JP お気づきの点等ございましたら、以下の点をお知らせください。

Example!

Korpus - Korpus - Carcase - Carcasse			Beslag - Fittings - Beschläge - Set de Montage		
			A X 8 197200014	B X 12 197200004	C X 4 1979110830
			D X 2 1970120000	H X 2 1978504022	J X 8 1978204210