

Hampton

Design by BoConcept

Samvejledning - Assembly Instructions - Montageanleitung - Instructions d'assemblage - Instrucciones de montaje

Examples

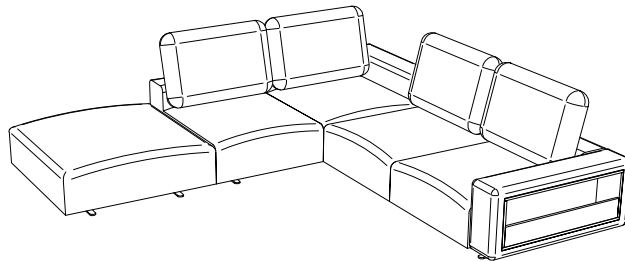
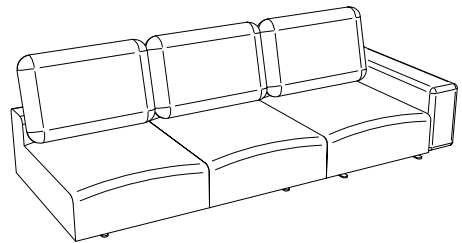
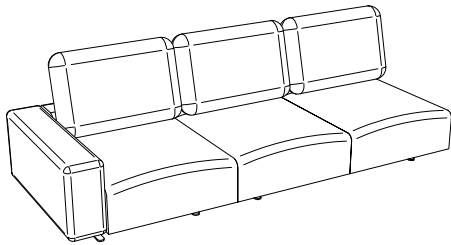
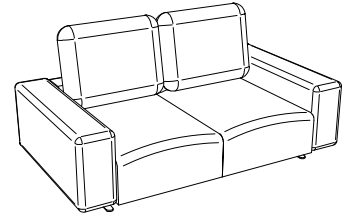
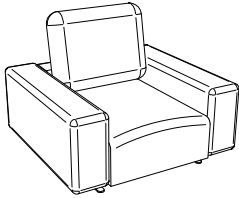

Fittings

697000029

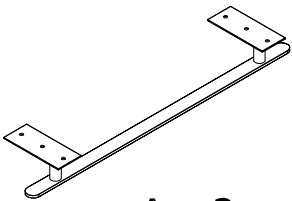

A x 2
Hampton leg

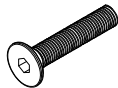

C x 12
Screw M8x40

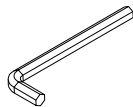

D x 1
Allen key 6mm

697000030



B x 4
Wheel



E x 16
Screw M6x40

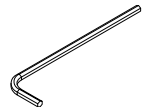

F x 1
Allen key 4mm

697000010

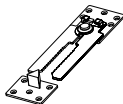

G x 2
Connector



H x 20
Woodscrew
3,5x25 mm

Hampton

Design by BoConcept

Samvejledning - Assembly Instructions - Montageanleitung - Instructions d'assemblage - Instrucciones de montaje

SOLO Modules

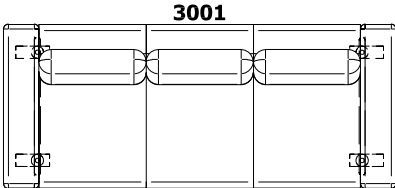

3001

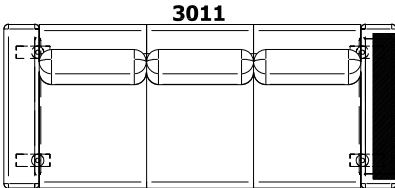

3011

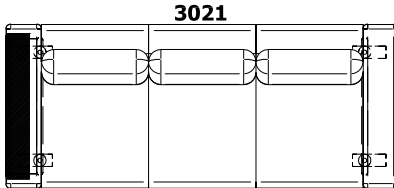

3021

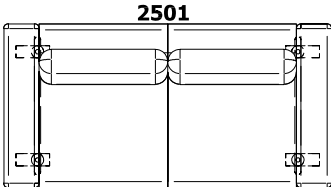

2501

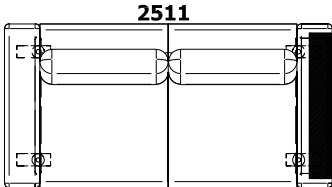

2511

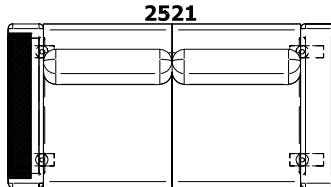

2521

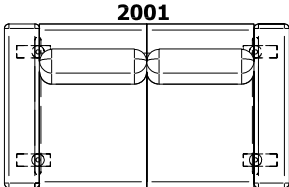

2001

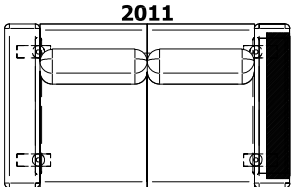

2011

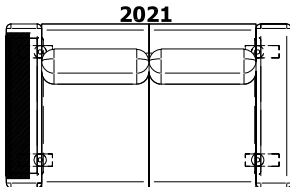

2021

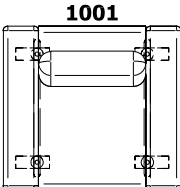

1001

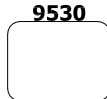

9530

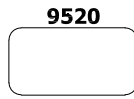

9520

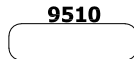

9510

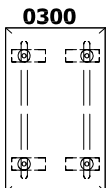

0300

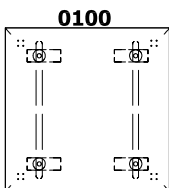

0100

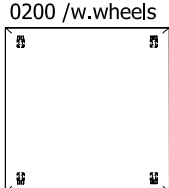

0200 /w.wheels

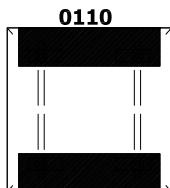

0110

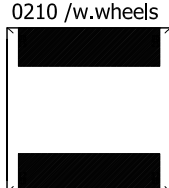

0210 /w.wheels

Hampton

Design by BoConcept

Samvejledning - Assembly Instructions - Montageanleitung - Instructions d'assemblage - Instrucciones de montaje

BUILDING Modules

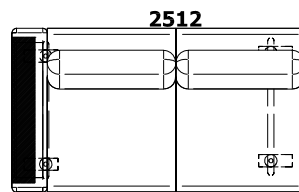
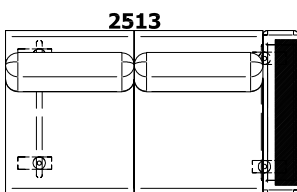
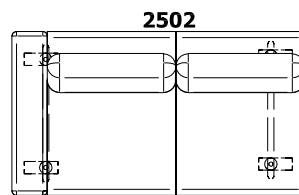
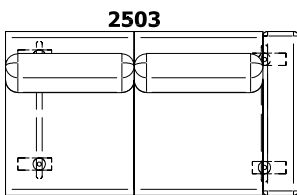
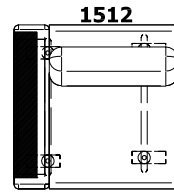
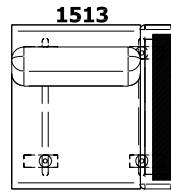
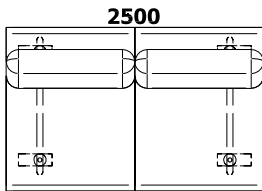
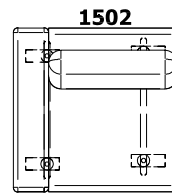
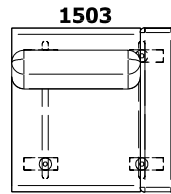
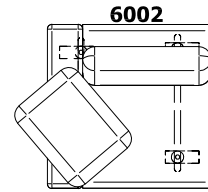
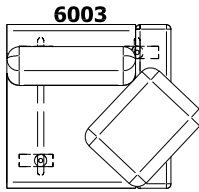
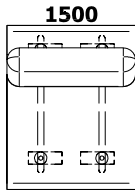

Hampton

Design by BoConcept

Samlevejledning - Assembly Instructions - Montageanleitung - Instructions d'assemblage - Instrucciones de montaje

Step 1:

Top view

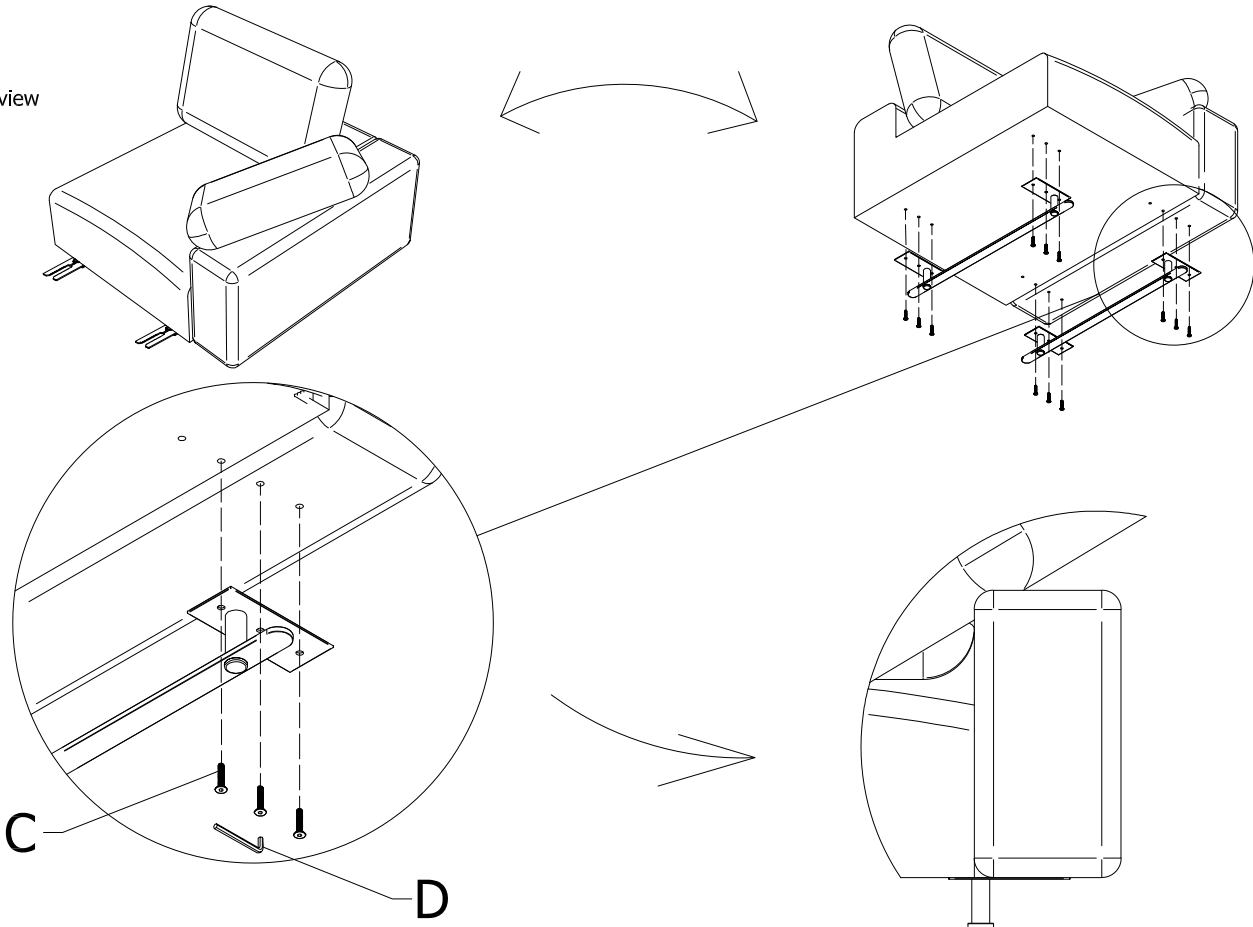

Step 2:

Attach connector's pieces to the following holes:

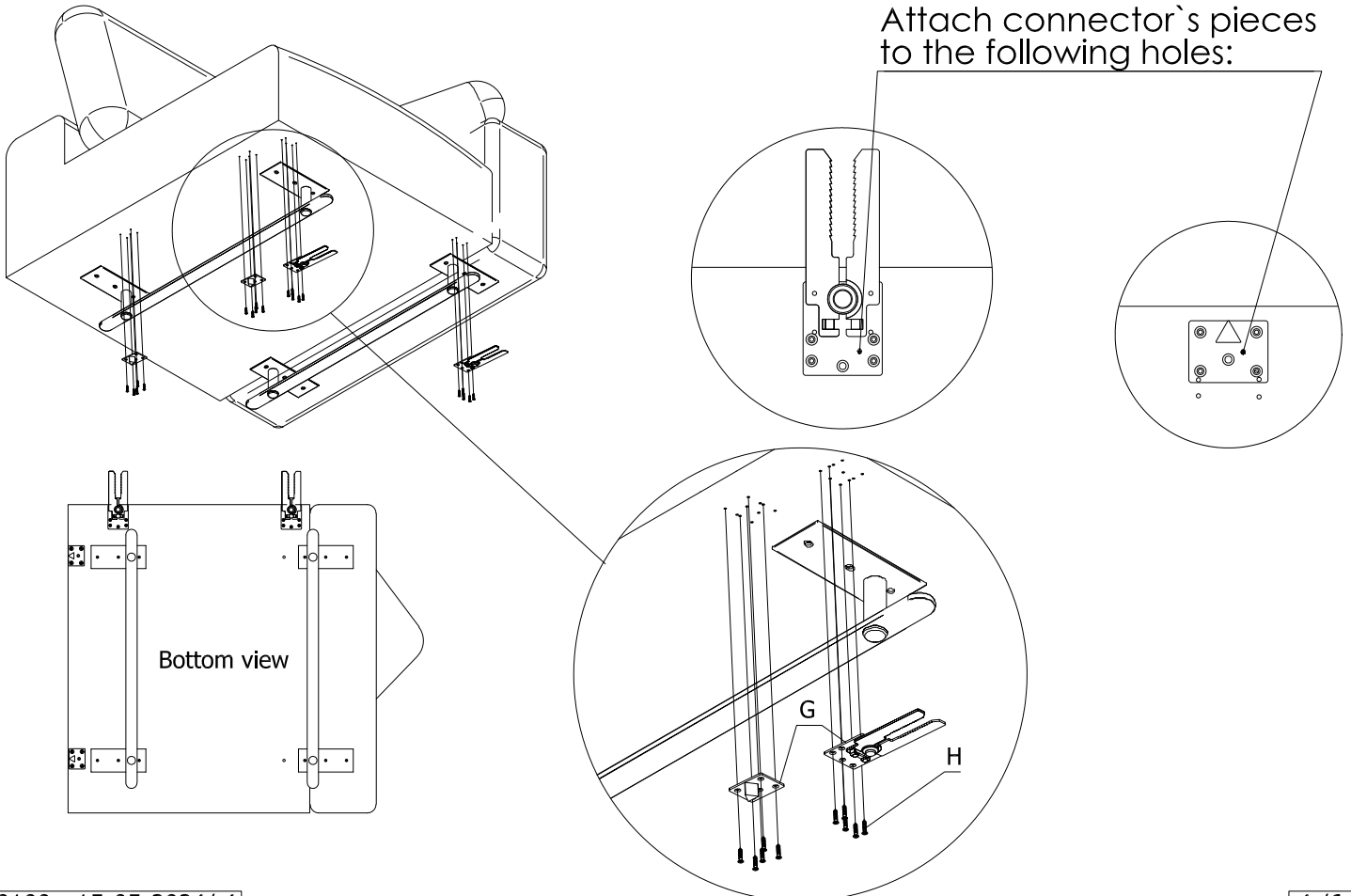

Hampton

Design by BoConcept

Samvejledning - Assembly Instructions - Montageanleitung - Instructions d'assemblage - Instrucciones de montaje

Step 3:

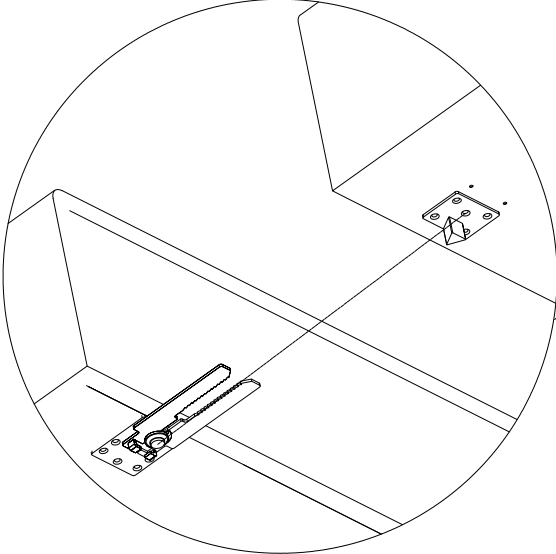
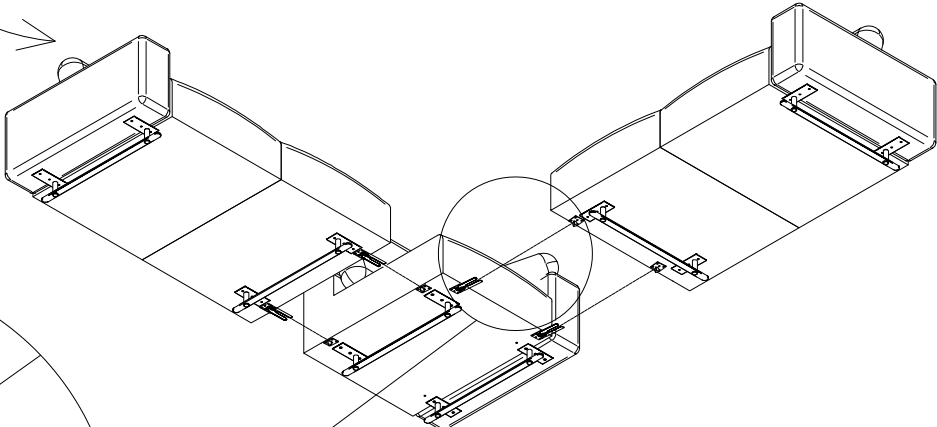
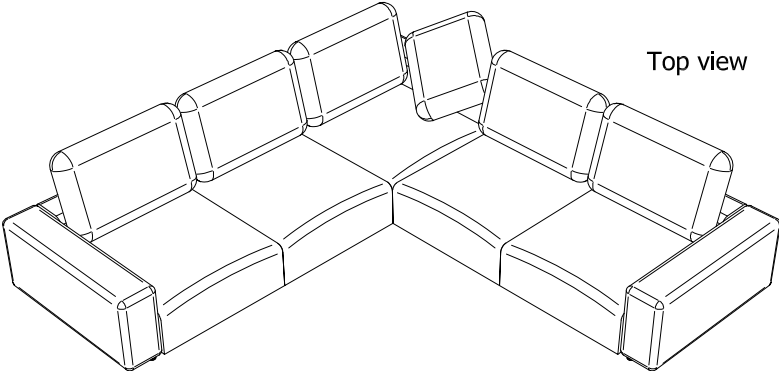

Hampton

Design by BoConcept

Samvejledning - Assembly Instructions - Montageanleitung - Instructions d'assemblage - Instrucciones de montaje

Cushion ajustement

